

# Volumeter TRZ 03-K



## PRODUCT INFORMATION

**Serving the Gas Industry  
Worldwide**



## VOLUMETER TRZ 03-K

Method of operation, Construction

### Method of operation

The TRZ 03-K Volumeter is a flow meter suitable for metering gases, where the rate of flow is indicated by a mechanical totalizer in units of volume (cubic meters at flowing conditions) under prevailing pressure and temperature.

The gas flow is constricted to a definite cross section and drives a coaxially mounted turbine wheel. The speed of the turbine wheel, which is proportional to the flow rate, is reduced by gearing and transmitted to the mechanical digital index.

The number of rotations is reduced by gearing in the meter head, which can be adjusted by selecting an appropriate pair of adjusting gears, so that cubic meters at flowing conditions are indicated by the mechanical totalizer. A reed contact (or an inductive sensor) located on the mechanical totalizer provides low-frequency pulses whose number is proportional to the volume at actual conditions flowed through.

In the case of larger nominal sizes and a higher pressure rating, the TRZ 03-K can be fitted with inductive high-frequency sensors scanning the turbine wheel (HF 3) and the reference wheel (HF 2). The reference wheel is a cam wheel located on the same shaft as the turbine wheel which enables the turbine wheel to be monitored.

### Construction

The meter case comprises the measuring element with the turbine wheel. A flow straightener located upstream of the measuring element substantially eliminates turbulences and swirl from the gas flow and directs the gas onto the turbine blades.

The rotary motion generated by the turbine wheel is transmitted by a magnetic coupling from the pressurized meter case to the unpressurized meter head.

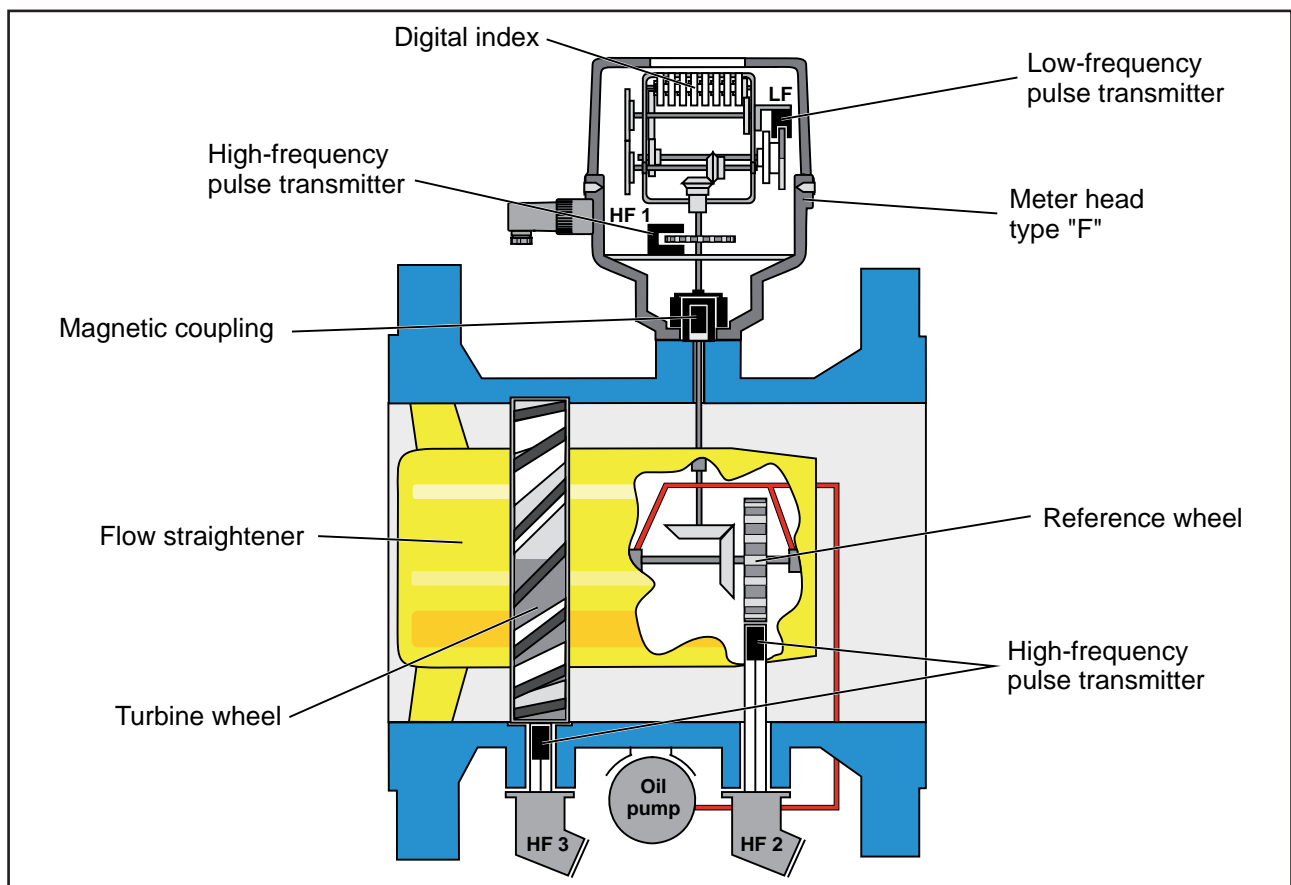

**Features**

**LF-Pulse transmitter (in the meter head)**

- Standard: reed contact
- Alternatively : inductive pulse transmitter
- Option: up to 3 LF pulse transmitters possible

**HF-pulse transmitter(Option)**

- In the meter head: Inductive pulse transmitter (HF 1), pulse frequency at  $Q_{max}$  approx. 100 Hz.
- In the meter case: Inductive pulse transmitter for scanning
  - the blades of the turbine wheel (HF 3, from DN 80)
  - the cams of the reference wheel (HF 2, from DN 100)

All inductive pulse transmitters provide volume pulses in compliance with NAMUR.

**Meter head (type “F”)**

- protection class IP 65
- Universally readable
- Totalizer unit and HF1 pulse transmitter are easily replaceable on site.

**Measuring range: up to 1:16**

**Nominal size: DN 50 through DN 600**

Special designs with larger nominal sizes up to DN 1000 are possible.

**Pressure rating: PN 10 through PN 100, ANSI 150 through ANSI 600**

Special designs with a higher pressure rating are possible.

**Operating temperature range:**

Standard design: -10°C to +50°C

Special designs for higher and/or lower temperatures are possible.

**Explosion protection**

The pulse transmitters are intrinsically safe; their type of protection is EEx ib IIC T6. Therefore, the TRZ 03-K can be operated in Zone 1.

**Long service life**

**p<sub>r</sub>-connection**

To connect the pressure transmitter of a PTZ corrector.

**Manufacturer’s test certificate**

In compliance with EN 10204/2.3, for strength and leak testing.

**Materials**

**Rotor:**

Delrin for DN 50 to DN 200 and PN 10 / PN 16.  
 Aluminium alloy for all other diameters and pressure ratings and for meters with HF sensors.  
 Aluminium rotors instead of delrin rotors on special request.

**Meter case material (standard)**

DN	PN					ANSI			
	10	16	25	40	64	100	150	300	600
50	Steel	Steel	Spheroidal cast iron	Spheroidal cast iron	Steel, welded	Steel, welded	Steel, welded	Cast steel	Cast steel
80	Steel	Steel	Spheroidal cast iron	Spheroidal cast iron	Steel, welded	Steel, welded	Steel, welded	Cast steel	Cast steel
100	Steel	Steel	Spheroidal cast iron	Spheroidal cast iron	Steel, welded	Steel, welded	Steel, welded	Cast steel	Cast steel
150	Steel	Steel	Spheroidal cast iron	Spheroidal cast iron	Steel, welded	Steel, welded	Steel, welded	Cast steel	Cast steel
200	Steel	Steel	Spheroidal cast iron	Spheroidal cast iron	Steel, welded	Steel, welded	Steel, welded	Cast steel	Cast steel
250	Steel	Steel	Spheroidal cast iron	Spheroidal cast iron	Steel, welded	Steel, welded	Steel, welded	Cast steel	Cast steel
300	Steel	Steel	Spheroidal cast iron	Spheroidal cast iron	Steel, welded	Steel, welded	Steel, welded	Cast steel	Cast steel
400	Steel	Steel	Spheroidal cast iron	Spheroidal cast iron	Steel, welded	Steel, welded	Steel, welded	Cast steel	Cast steel
500	Steel	Steel	Spheroidal cast iron	Spheroidal cast iron	Steel, welded	Steel, welded	Steel, welded	Cast steel	Cast steel
600	Steel	Steel	Spheroidal cast iron	Spheroidal cast iron	Steel, welded	Steel, welded	Steel, welded	Cast steel	Cast steel

Steel Spheroidal cast iron   
 Cast steel Steel, welded

Any material available on special request.

## VOLUMETER TRZ 03-K

Accuracy, Approval, Pressure loss

### Accuracy

Error limits (standard):

±2% for  $Q_{\min}$  to  $0.2 Q_{\max}$  (DN 50, DN 80: ±3%)

±1% for  $0.2 Q_{\max}$  to  $Q_{\max}$  (DN 50: ±1.5%)

These limits apply in the event of a steady, swirl-free flow.

Higher accuracy available on special request.

**Repeatability:** ±0.1%

All gas meters are tested in the factory with air under atmospheric pressure.

### Approvals

The gas meters substantially comply with PTB and EC/EEC regulations (G120 3B of the EC dated September 6, 1971).

The TRZ 03-K Volumeter has been examined according to the pressure equipment directive 97/23/EC by DVGW and is registered under the product ident number CE-0085BN0292.

The TRZ 03-K Volumeter meets the OIML guideline IR-32/89, Annex A.

4

### Pressure loss

The pressure loss  $\Delta p$  stated in the table applies to natural gas at  $Q_{\max}$  and 1 bar. From this, the pressure loss at actual conditions can be calculated using the following formula:

$$\Delta p_A = \Delta p \cdot \frac{\rho_N}{0.83} \cdot p_A \cdot \left( \frac{Q_A}{Q_{\max}} \right)^2$$

$\Delta p_A$  = Pressure loss at actual conditions ( $p_A$ ,  $Q_A$ ) in mbar

$\Delta p$  = Pressure loss at  $Q_{\max}$  with natural gas at 1 bar in mbar (see table)

$\rho_N$  = Standard density of the gas in kg/m<sup>3</sup>

$p_A$  = Operating pressure in bar (absolute)

$Q_A$  = Flow rate at actual conditions in m<sup>3</sup>/h

$Q_{\max}$  = Maximum flow rate in m<sup>3</sup>/h (see table)

Example:

Air,  $\rho_N = 1.29 \text{ kg/m}^3$ , nominal meter size DN 100,

$Q_{\max} = 400 \text{ m}^3/\text{h}$ ,  $p_A = 1.1 \text{ bar(a)}$ ,  $Q_A = 250 \text{ m}^3/\text{h}$ .

Take from the table:  $\Delta p = 4 \text{ mbar}$ .

Hence:

$$\Delta p_A = 4 \cdot \frac{1.29}{0.83} \cdot 1.1 \cdot \left( \frac{250}{400} \right)^2 \text{ mbar} = 2,7 \text{ mbar}$$

Nominal size DN		Max. flow rate $Q_{\max}$	$V_{NF}^*$	$\Delta p$	HF-pulse transmitter (Option)	
mm	in.	m <sup>3</sup> /h	m <sup>3</sup>	mbar	HF2	HF3
50	2"	6-100	0,1	5	-	-
80	3"	13-160	1	2	-	•
		16-250	1	6		
		25-400	1	14		
100	4"	25-400	1	4	-	•
		40-650	1	10		
150	6"	40-650	1	2	-	•
		65-1000	1	6		
		100-1600	10	12		
200	8"	100-1600	10	3	-	•
		160-2500	10	8		
250	10"	160-2500	10	3	◦	•
		250-4000	10	7		
300	12"	250-4000	10	4	◦	◦
		400-6500	10	9		
400	16"	400-6500	10	3	•	•
		650-10000	10	8		
500	20"	650-10000	10	4	◦	◦
		1000-16000	100	9		
600	24"	1000-16000	100	4	◦	•
		1600-25000	100	9		

\* $V_{NF}$ : volume at actual conditions per LF-pulse

- not available

◦ not available for all pressure classes

• available for all pressure classes

**Types of gas**

The TRZ 03-K standard design is suitable for use with all gases in compliance with the DVGW code of practice G260. The materials used are appropriate for gases and fuel gases, such as natural gas, refinery gas, gaseous liquids and their mixtures, nitrogen, CO<sub>2</sub> (dry), air and all inert gases.

For aggressive gases (e.g. biogas, acid gas or ethylene), there are special designs available with PTFE lining, special material, special lubrication, etc.

**Mounting and operating instruction**

The TRZ 03-K Volumeters can be operated in any mounting position up to the nominal size of DN 200. From the nominal size of DN 250, they can only be installed in a horizontal position.

**Special instructions for startup and operation:**

Turbine meters are precise measuring instruments and must therefore be carefully handled during transport, storage and operation.

Do not fill any downstream pipelines or station sections via the Volumeter. This may result in excessive flow rates with resultant damage to the turbine wheel.

The gas meter has been designed for short-term overload operation at up to 1.2 times the value of Q<sub>max</sub>. Such load conditions should be avoided, however, in order to protect the TRZ 03-K from any unnecessarily high flow rates. The gas flow must be free of shocks or pulsations, foreign particles, dust or liquids. Otherwise it is recommended that filters and separators be installed. No components affecting the gas flow are permitted directly upstream of the Volumeter (see DVGW guidelines and PTB guideline G 13).

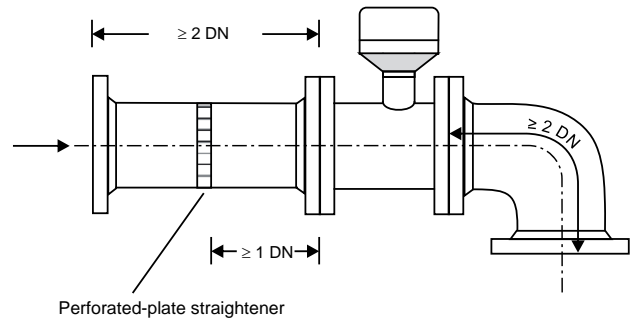

In each case, a 2 DN inlet pipe and a 2 DN outlet pipe are required, while also a bend may be used as outlet pipe. If flow perturbation (e.g. due to a gas pressure controller) occurs upstream of the inlet pipe, it is additionally necessary to use a perforated-plate straightener. There are perforated-plate straighteners available complying with ISO 5167-1 or of the type RMG LP-35, the latter resulting in a pressure loss which is 2.5 times lower than that of the standardized flow straightener.

LP-35 perforated-plate straightener

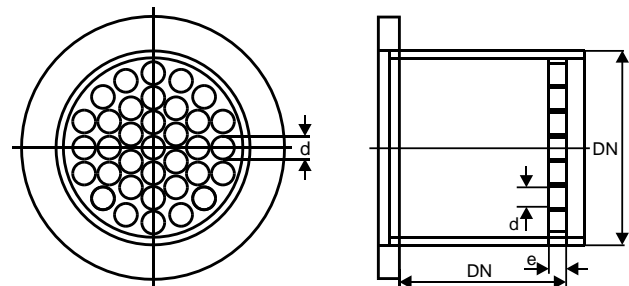

$$d = e = 0.13 \cdot DN$$

Reducers or expansion fittings must be installed upstream of the inlet pipe, and their opening angle must not exceed 30°.

The gas meter must be installed in weather-proof locations. For outside installations, appropriate guards must be provided against direct weathering influences.

## VOLUMETER TRZ 03-K

Pulse outputs, Maintenance, Order information

### Pulse outputs

The meter head is fitted with a reed contact as LF pulse transmitter as standard feature. But optionally, another two sensors can be fitted, e.g. another LF pulse transmitter (inductive sensor with output pulses complying with NAMUR or reed contact) and an HF1 pulse transmitter (NAMUR).

Connection is made by means of a 7-pin Binder plug:

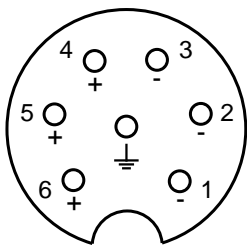

- 1, 4: LF (reed contact)
- 2, 5: LF or HF 1-signal
- 3, 6: HF1 (NAMUR)

If only one LF pulse transmitter is fitted, it is always connected to the contacts 1 and 4; a single HF1 pulse transmitter is always connected to the contacts 3 and 6. If high-frequency pulse transmitters (with output pulses complying with NAMUR) are fitted which scan either the turbine wheel (HF3) or the reference wheel (HF2), each of them is connected separately using a Binder plug at the front of the device:

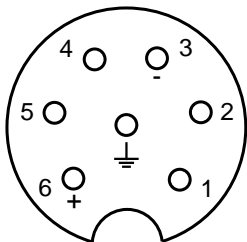

- 3, 6: HF2 or HF3-signal

The contacts 1, 2, 4 and 5 are not assigned.

All pulse transmitters are intrinsically safe and may be connected only to certified intrinsically safe circuits for use in areas subject to explosion hazards.

### Maximum pulse transmitter frequencies:

LF: 0.3 Hz                      HF1: 300 Hz

HF2: 2.1 kHz                  HF3: 2.1 kHz

The phase displacement between the signals from the HF2 and HF3 pulse transmitters is 180°.

### Maintenance

All turbine meters are fitted with a lubricator (DN 50 through DN 150: permanent lubrication, from PN 25/ANSI 300 pushbutton pump; DN 200: pushbutton pump; from DN 250: lever pump).

Lubrication must be performed in compliance with the operating instructions (see also the lubrication instruction plate of the gas meter). If clean gas is used, lubrication is to be performed at 3-month intervals, whereas lubrication must be performed more frequently if dust- and/or condensate-laden gas is used.

### Order information

- Nominal size of the pipeline
- Volumetric flow rate in Nm<sup>3</sup>/h or m<sup>3</sup>/h (min/max)
- Operating pressure (min/max) in bar g or bar a
- Operating temperature (min/max)
- Ambient temperature (min/max)
- Type of gas to be used
- Pressure rating and DIN or ANSI flange design
- Direction of flow / mounting position
- Accessories: inlet pipe, volume corrector, etc.
- Options: HF pulse outputs, etc.
- Special designs, e.g. for aggressive gases

Measuring ranges, dimensions, weights

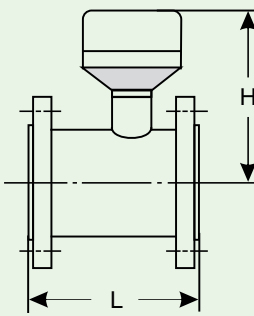
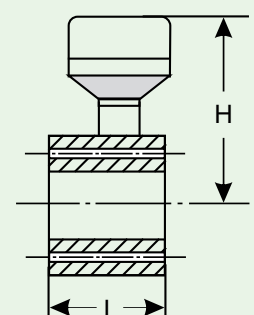
Nominal size mm inches	Measuring range (m <sup>3</sup> /h)		Pressure rating	Dimensions		Weight app. kg	Case design
	Q <sub>min</sub>	Q <sub>max</sub>		L	H		
50 2"	6	100	PN 10, 16, 25, 40 ANSI 150, 300	150	212	10	<p style="text-align: center;"><b>Flanged</b></p> 
80 3"	13 16 25	160 250 400	PN 10, 16, 25, 40 ANSI 150	120	245	14	
100 4"	25 40	400 650	PN 10, 16, 25, 40 ANSI 150	150	255	25	
150 6"	40 65 100	650 1000 1600	PN 10, 16, 25, 40 ANSI 150	175	285	40	
200 8"	100 160	1600 2500	PN 10, 16, 25, 40 ANSI 150	200	305	60	
250 10"	160 250	2500 4000	PN 10, 16, 25, ANSI 150	300	300	70	
300 12"	250 400	4000 6500	PN 10, 16, 25 ANSI 150	300	365	100	
			PN 40, 64, 100 ANSI 300, 600	450	415	200	
400 16"	400 650	6500 10000	PN 10, 16, 25 ANSI 150	600	390	280	
			PN 40, 64, 100 ANSI 300, 600	600	450	400	
500 20"	650 1000	10000 16000	PN 10, 16, 25 ANSI 150	750	445	500	
			PN 40, 64, 100 ANSI 300, 600	750	515	650	
600 24"	1000 1600	16000 25000	PN 10, 16, 25 ANSI 150	900	465	650	
			PN 40, 64, 100 ANSI 300, 600	900	580	850	
50 2"	6	100	PN 64, 100 ANSI 600	80	212	15	<p style="text-align: center;"><b>Single-flanged</b></p> 
80 3"	13 16 25	160 250 400	PN 64, 100 ANSI 300, 600	120	245	35	
100 4"	25 40	400 650	PN 64, 100 ANSI 300, 600	150	255	50	
150 6"	40 65 100	650 1000 1600	PN 64, 100 ANSI 300, 600	175	285	100	
200 8"	100 160	1600 2500	PN 64, 100 ANSI 300, 600	200	305	130	
250 10"	160 250	2500 4000	PN, 40, 64, 100 ANSI 300, 600	250	300	200	

DN 700 to DN 1000 on request

### **For More Information**

To learn more about RMG's advanced gas solutions, contact your RMG account manager or visit [www.rmg.com](http://www.rmg.com)

### **GERMANY**

#### **Honeywell Process Solutions**

RMG Regel + Messtechnik GmbH  
Osterholzstrasse 45  
34123 Kassel, Germany  
Tel: +49 (0)561 5007-0  
Fax: +49 (0)561 5007-107

#### **Honeywell Process Solutions**

RMG Messtechnik GmbH  
Otto-Hahn-Strasse 5  
35510 Butzbach, Germany  
Tel: +49 (0)6033 897-0  
Fax: +49 (0)6033 897-130

#### **Honeywell Process Solutions**

RMG Gaselan Regel + Messtechnik GmbH  
Julius-Pintsch-Ring 3  
15517 Fürstenwalde, Germany  
Tel: +49 (0)3361 356-60  
Fax: +49 (0)3361 356-836

#### **Honeywell Process Solutions**

WÄGA Wärme-Gastechnik GmbH  
Osterholzstrasse 45  
34123 Kassel, Germany  
Tel: +49 (0)561 5007-0  
Fax: +49 (0)561 5007-207

### **POLAND**

#### **Honeywell Process Solutions**

Gazomet Sp. z o.o.  
ul. Sarnowska 2  
63-900 Rawicz, Poland  
Tel: +48 (0)65 5462401  
Fax: +48 (0)65 5462408

### **ENGLAND**

#### **Honeywell Process Solutions**

Bryan Donkin RMG Gas Controls Ltd.  
Enterprise Drive, Holmewood  
Chesterfield S42 5UZ, England  
Tel: +44 (0)1246 501-501  
Fax: +44 (0)1246 501-500

### **CANADA**

#### **Honeywell Process Solutions**

Bryan Donkin RMG Canada Ltd.  
50 Clarke Street South, Woodstock  
Ontario N4S 0A8, Canada  
Tel: +1 (0)519 5398531  
Fax: +1 (0)519 5373339

### **USA**

#### **Honeywell Process Solutions**

Mercury Instruments LLC  
3940 Virginia Avenue  
Cincinnati, Ohio 45227, USA  
Tel: +1 (0)513 272-1111  
Fax: +1 (0)513 272-0211

### **TURKEY**

#### **Honeywell Process Solutions**

RMG GAZ KONT. SIS. ITH. IHR. LTD. STI.  
Birlik Sanayi Sitesi, 6.  
Cd. 62. Sokak No: 7-8-9-10  
TR - Sasmaz / Ankara, Turkey  
Tel: +90 (0)312 27810-80  
Fax: +90 (0)312 27828-23

